



308 SW (T92)

PEUGEOT

NOT: 2678

Réf.: 1608868480

FR NOTICE DE POSE A USAGE PROFESSIONNEL / LES PHOTOS ET LES DESSINS NE SONT PAS CONTRACTUELS

GB FITTING INSTRUCTIONS FOR PROFESSIONAL FITTERS / THE PHOTOGRAPHS AND THE DRAWINGS ARE NOT CONTRACTUAL

ES INSTRUCCIONES DE MONTAJE PARA USO PROFESIONAL / LAS FOTOGRAFÍAS Y LOS DIBUJOS NO SON CONTRACTUALES

P MANUAL DE MONTAGEM PARA UTILIZAÇÃO PROFSSIONAL / AS FOTOGRAFIAS E OS DESENHOS NÃO SÃO CONTRATUAIS

DE MONTAGEANLEITUNG FÜR PROFESSIONELLEN EINSATZ / DIE FOTOS UND DIE ZEICHNUNGEN SIND NICHT VERTRAGLICH

IT ISTRUZIONI DI POSA AD USO PROFESSIONALE / LE FOTOGRAFIE ED I DISEGNI NON SONO CONTRATTUALI

NL MONTAGEHANDLEIDING VOOR PROFESSIONEEL GEBRUIK / DE FOTO'S EN DE TEKENINGEN ZIJN NIET CONTRACTUEEL

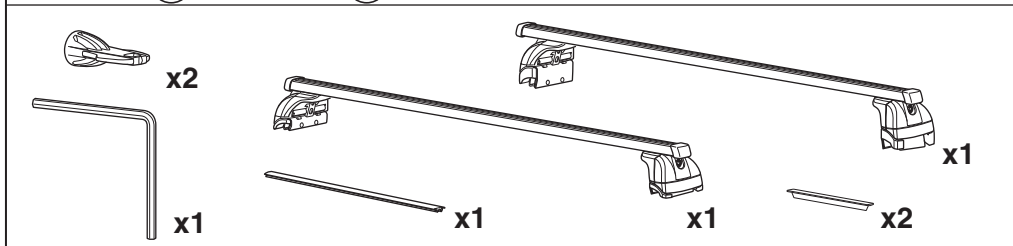
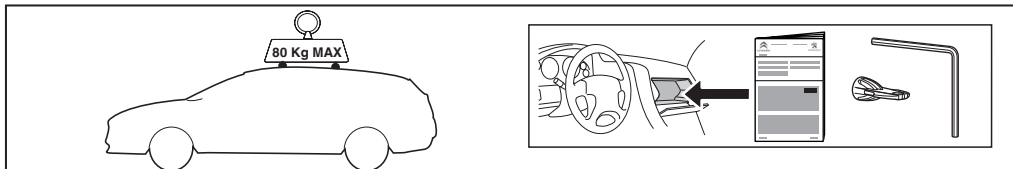
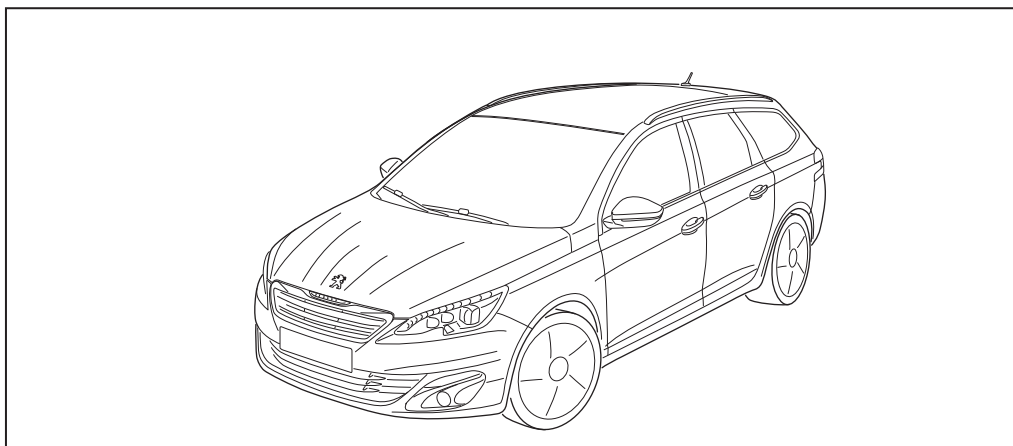

1

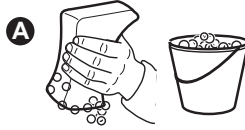
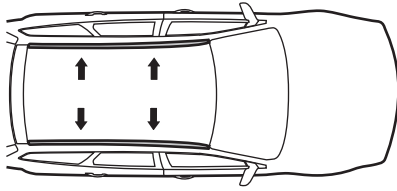

2

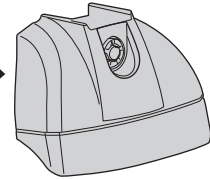
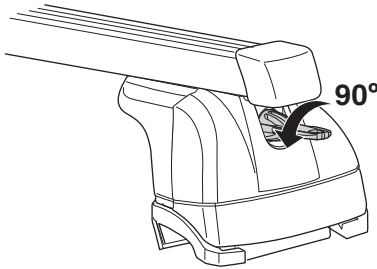

x4

3

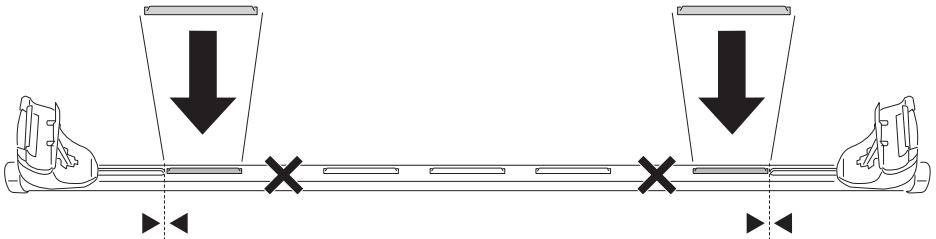
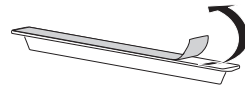
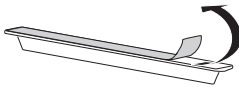
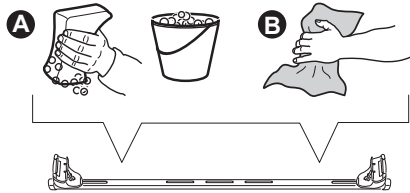
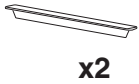

4

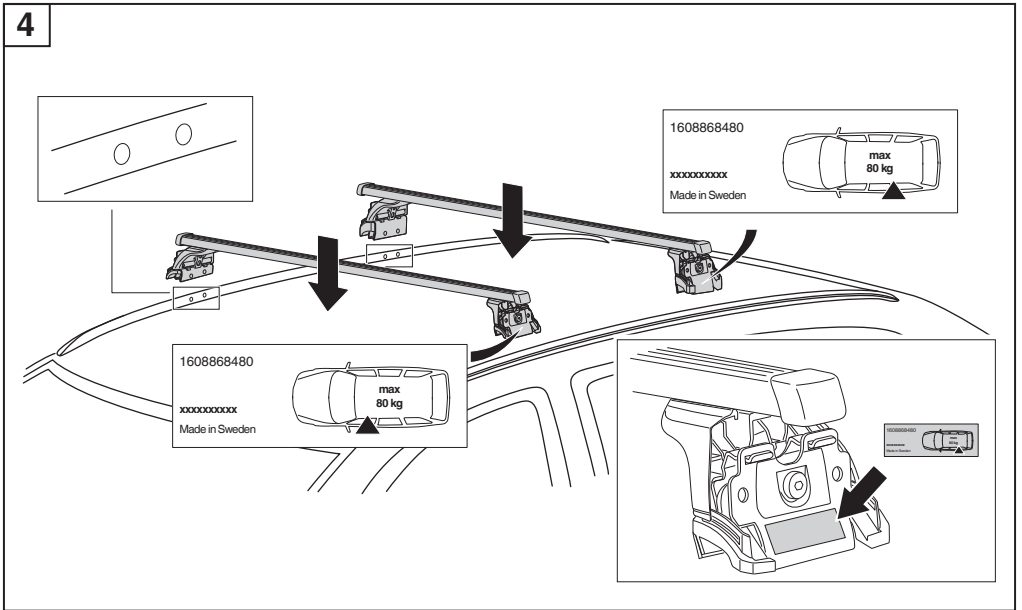

5

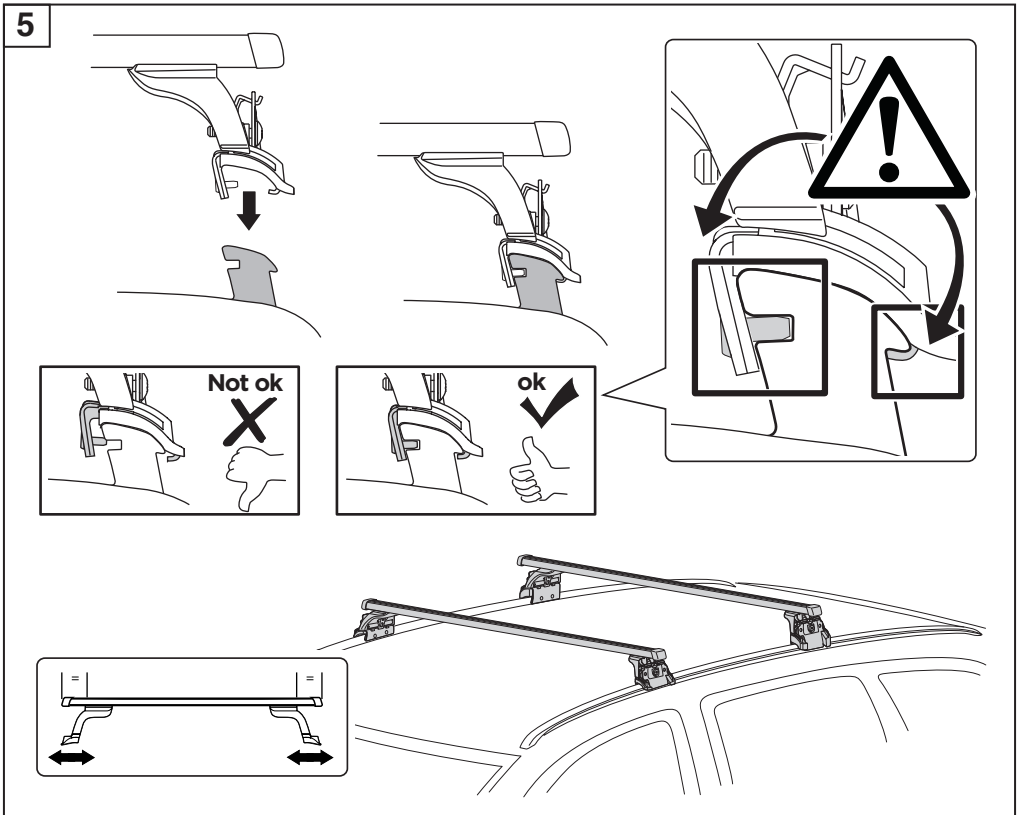

6

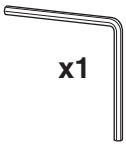

x1

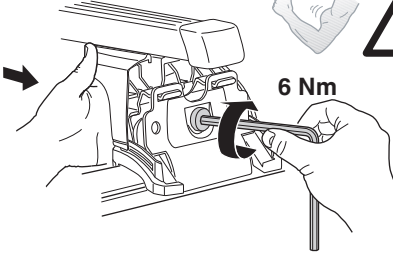
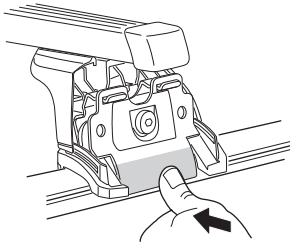

6 Nm

A 50 %

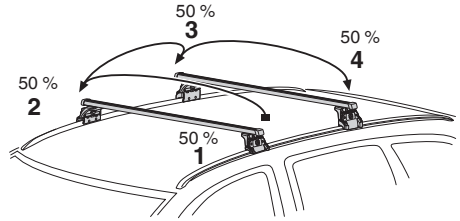

B 100 %

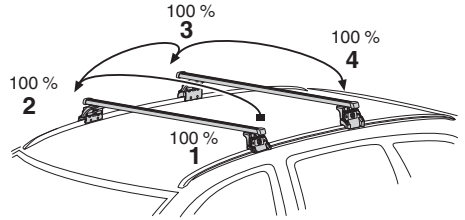

7



x1

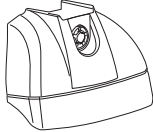

x4

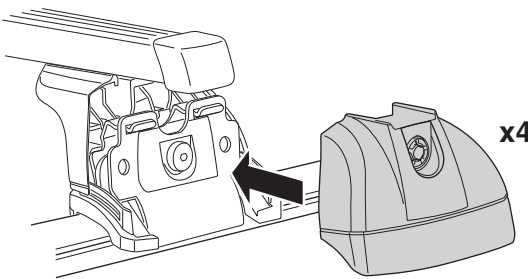

x4

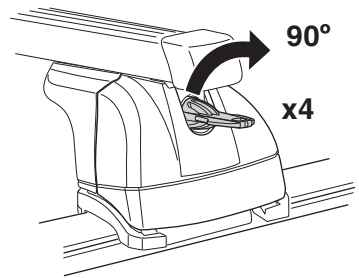

90°

x4

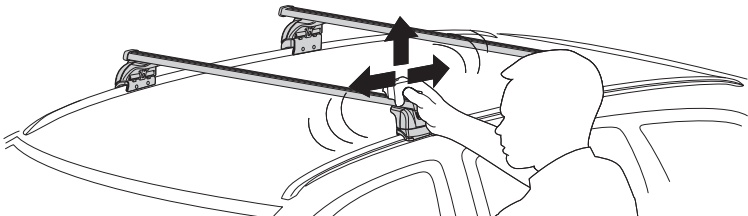

8

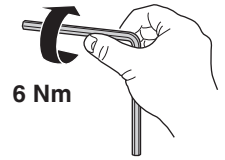
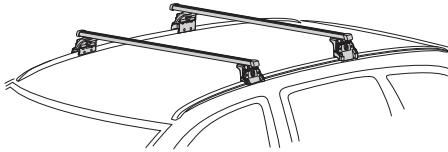
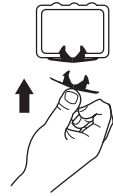
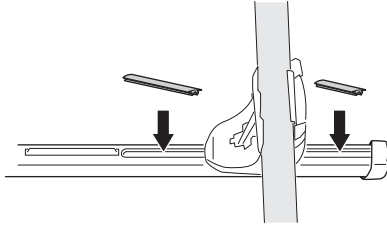
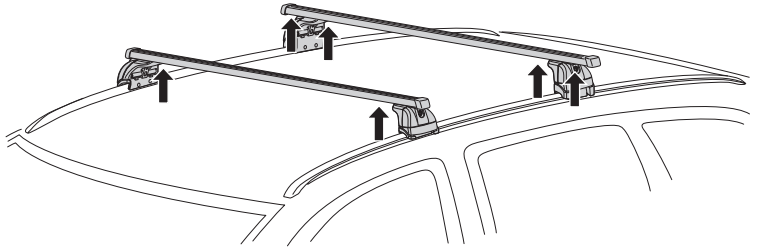
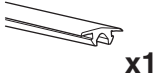

6 Nm

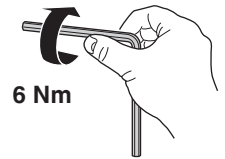
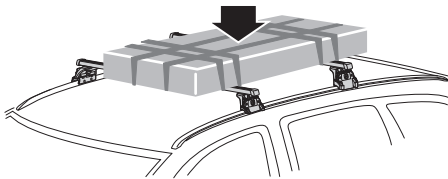

6 Nm



50 km

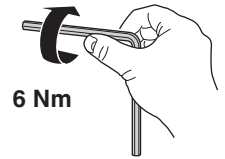

6 Nm

9

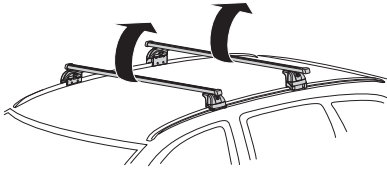

A

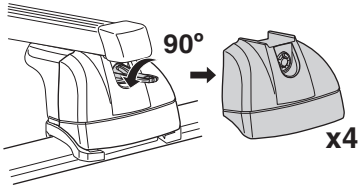

B

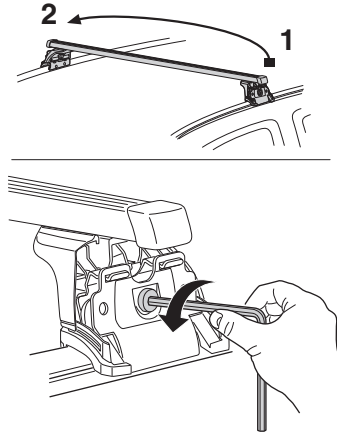

C

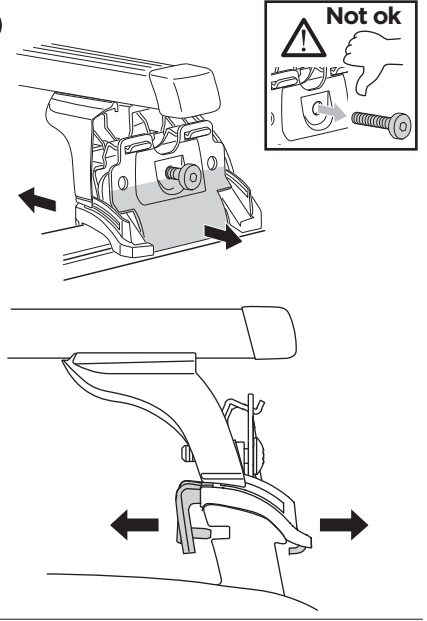

D

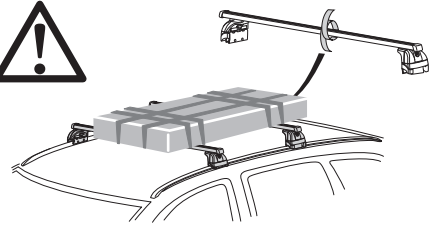
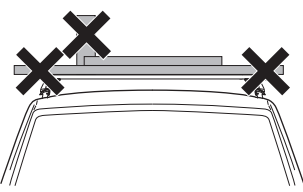
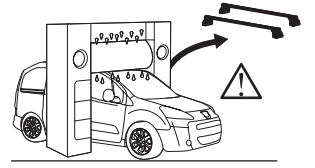
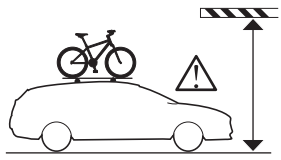
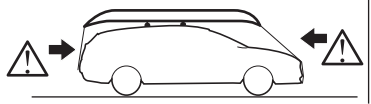
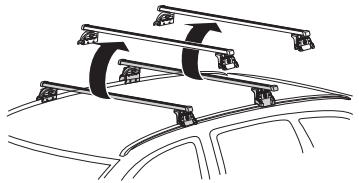

FR Sécurité

- Ces barres ont été conçues pour être placées à un endroit précis du véhicule.
- La fixation sur le véhicule n'est plus garantie si le positionnement est différent de celui indiqué sur cette notice.
- Les vis de fixation doivent être impérativement resserrées, les sangles d'arrimage vérifiées, après quelques kms de roulage et périodiquement au cours du trajet.
- L'arrimage des bagages avec des liens élastiques (sandow, tendeurs, etc...) est interdit; sangles conseillées.
- N'intercaler aucune garniture supplémentaire (caoutchouc, plastique ou autre) entre la patte de fixation et la carrosserie, la bonne tenue des barres ne serait plus assurée.
- Tenir compte du nouveau comportement du véhicule (vent latéral, virage et freinage) lorsque les barres sont chargées.
- Planches à voile et charges longues: réduire la vitesse, 90 km/heure conseillé. (utiliser les crochets d'arrimage du véhicule)
- Pour économie d'énergie, les barres seront enlevées si elles ne sont pas utilisées.
- La pose, sur les barres de toit, d'un accessoire non référencé par Automobiles Citroën/Peugeot peut entraîner des dégradations de votre véhicule. Nous vous remercions de bien vouloir noter cette particularité et vous conseillons de prendre contact avec un représentant de la marque pour vous faire présenter la gamme d'accessoires référencés.

Le non respect de cette notice d'utilisation dégage la responsabilité du constructeur.

GB Safety

- These bars are designed to be fitted in one specific position on the vehicle.
- The attachment to the vehicle is not guaranteed if the position is different from that shown in these instructions.
- The attachment screws must be re-tightened and the stowage straps checked after a few kilometres' haulage and thereafter periodically during the journey.
- It is forbidden to use elastic lashings (bungee cord, etc). We recommend webbing straps.
- Do not place any additional material (rubber, plastic, etc) between the feet and car body, it could prevent the bars holding properly.
- Bear in mind the effect on the handling of your vehicle when the bars are loaded (side wind stability, cornering and braking)
- When carrying sailboards and other long loads do not exceed 90 km/h.
- The bars should be removed if they are not used.
- Fitting an accessory not stocked by Citroën/Peugeot Automobiles onto the roof bars may damage your vehicle. We ask you to take note of this information and advise you to contact a brand representative to view the range of accessories stocked.

The manufacturer accepts no responsibility if these instructions are not followed.

ES Seguridad

- Estas barras han sido diseñadas para ser colocadas en un lugar preciso del vehículo
- La fijación en el vehículo no está garantizada si su posición es diferente a la indicada en estas instrucciones
- Es obligatorio volver a apretar los tornillos de fijación y se deberán comprobar las correas de amarre después de circular unos kilómetros y periódicamente durante el trayecto.
- Se prohíbe la sujeción del equipaje con ataduras elásticas (pulpas, tensores, etc.). Se recomienda la utilización de correas.
- No intercalar ninguna guarnición suplementaria (goma, plástico u otro) entre la pata de fijación y la carrocería, ya que no se garantizaría la correcta estabilidad de las barras.
- Tener en cuenta el nuevo comportamiento del vehículo (viento lateral, giros y frenado) cuando las barras están cargadas.
- Si se transportan tablas de vela y cargas largas, se aconseja reducir la velocidad a 90 km/h .
- Las barras deberán retirarse si no se utilizan.
- La colocación, en las barras del techo, de un accesorio que no esté incluido en las referencias de Automóviles Citroën/Peugeot puede provocar graves daños en su vehículo. Le rogamos que tome nota de esta particularidad y le aconsejamos que se ponga en contacto con un representante de la marca para que le presente la gama de accesorios incluidos en sus referencias.

Constructor no se responsabiliza en caso de incumplimiento de estas instrucciones de utilización.

P Segurança

- Estas barras foram concebidas para ser colocadas num lugar bem determinado da viatura.
- A fixação sobre a viatura já não será garantida se o posicionamento é diferente do indicado sobre estas instruções.
- Os parafusos de fixação devem imperativamente ser apertados, as correias de fixação verificadas, após alguns quilómetros de rodagem e periodicamente durante o trajeto.
- A amarração das bagagens com elásticos (sandow, esticadores, etc...) é proibida; aconselhamos as correias.
- Não intercalar nenhuma guarnição suplementar (borracha, plástico ou outros) entre a pata de fixação e a carroçaria, o bom comportamento das barras já não seria garantido
- Tomar em consideração o novo comportamento da viatura (vento lateral, curvas e travagem), quando as barras estão carregadas.
- Windsurfs e cargas compridas: reduzir a velocidade, 90 Km/hora aconselhados.
- Caso não sejam utilizadas, as barras de tecto devem ser retiradas.
- A colocação, sobre as barras do tejadilho, de um acessório não referenciado pela Citroën/Peugeot pode provocar degradações no seu veículo. Queira tomar boa nota desta particularidade. Sugerimos que contacte um representante da marca para que este lhe apresente a gama de acessórios referenciados.

O não respeito destes instruções de utilização liberta o construtor de qualquer responsabilidade.

DE Sicherheit

- Diese Profile wurden für eine Befestigung an einem bestimmten Dachbereich ausgelegt
- Die sichere Befestigung auf dem Fahrzeug ist nicht mehr gewährleistet, wenn der Montagebereich von dem in dieser Anleitung angegebenen abweicht.
- Die Befestigungsschrauben müssen unbedingt nach einigen Fahrkilometern und regelmäßig während der Fahrt nachgezogen und die Koppelungsgute geprüft werden.
- Das Festzurren von Gepäckstücken mit Elastikbändern (Sandow, Gummispannern usw...) ist untersagt - empfohlen sind Gurtbänder.
- Keinesfalls zwischen die Auflager und der Karosserie Zwischenelemente einlegen (Gummi, Kunststoff o.ä.), da hierdurch die Halterungsfestigkeit der Gepäckprofile beeinträchtigt wird.
- Im geladenen Zustand verändertes Fahrzeugverhalten berücksichtigen (Seitenwind, Kurvenfahrt u. Bremsverhalten).
- Surfbretter u. längere Lasten: Geschwindigkeit reduzieren, empfohlene Richtgeschwindigkeit: 90 km/h.
- Falls nicht verwendet, die Dach-Trägerprofile abnehmen.
- Das Anbringen eines nicht von Automobilen Citroën/Peugeot nachgewiesenen Zubehörs auf den Dachträgern kann eine Beschädigung Ihres Fahrzeugs mit sich bringen. Wir bitten Sie, dies zu beachten und empfehlen Ihnen, Kontakt mit einem Vertreter dieser Marken aufzunehmen, der Ihnen die nachgewiesenen Zubehöre vorstellen wird.

Die Nichtbeachtung dieser Anleitung stellt der Hersteller von jeglichem Haftungsanspruch frei

IT Sicurezza

- Queste barre sono state concepite per essere posizionate in un punto preciso del veicolo.
- Il fissaggio sul veicolo non è più garantito se il posizionamento è differente da quello indicato sulle istruzioni
- Le viti di fissaggio devono essere tassativamente serrate, le cinghie di ancoraggio verificate dopo aver guidato per qualche chilometro e periodicamente durante il tragitto.
- E' vietata la sistemazione dei bagagli con lacci elastici (sandow, tenditori, ecc.); si consigliano cinghie.
- Non intercalate alcuna guarnizione supplementare (caucciù, plastica o altro), fra le piastrine di fissaggio e la carrozzeria, in quanto la buona tenuta delle barre non sarebbe più assicurata.
- Tenete conto del nuovo comportamento del veicolo (vento laterale, curve e frenate), quando le barre sono cariche.
- Tavole a vela e carichi lunghi: ridurre la velocità. Si consigliano 90 km l'ora.
- Qualora utilizzate le sbarre verranno tolte.
- La posa, sulle barre portatutto, di un accessorio non raccomandato da Citroën/Peugeot può comportare il deterioramento del vostro veicolo. Vi saremmo grati se voleste prendere nota di questa particolarità e vi invitiamo a prendere contatto con un rappresentante della casa produttrice per farvi presentare la gamma degli accessori raccomandati.

Il non rispetto di queste istruzioni annulla ogni responsabilità della costruttore.

NL Veiligheid

- De dragers zijn zo gemaakt dat ze op een bepaalde plaats op de wagen moeten worden aangebracht.
- De bevestiging op de wagen is niet gegarandeerd indien de dragers anders worden aangebracht dan in deze handleiding staat aangegeven
- De bevestigingsschroeven na een paar kilometer en vervolgens regelmatig tijdens de rit opnieuw aandraaien en de riemen controleren.
- Het vastzetten van de bagage met elastische binders (snelbinder, spin, enz...) is verboden; gebruik van riemen is aangeraden.
- Breng vooral geen extra (rubber, plastic of andere) bescherming aan tussen de bevestigingslip en de carrosserie. Hierdoor zou het houvast van de dragers niet meer verzekerd zijn
- Houdt rekening met het gewijzigde rijgedrag van uw wagen (zijwind, bochten, remmen), wanneer de dragers zijn beladen.
- Surfplanken en andere lange voorwerpen: snelheid beperken, 90 km/uur aanbevolen.
- Na gebruik de stangen verwijderen.
- Het plaatsen op de alledragers van accessoires die niet zijn voorzien van een referentienummer van Automobilen Citroën/Peugeot kan tot beschadiging van uw voertuig leiden. Wij verzoeken u hiermee rekening te houden. Een vertegenwoordiger van het merk kan u de accessoires tonen die voorzien zijn van een referentienummer.

Het niet nakomen van deze gebruikershandleiding ontslaat de producent van elke aansprakelijkheid