



308
308 HYBRID
(P51)
(P51 PHEV)

308 SW
308 SW HYBRID
(P52)
(P52 PHEV)

408
408 HYBRID
(P54)
(P54 PHEV)

2008
e-2008
(P24)
(e-P24)

Partner
e-Partner
(K9)
(eK9)

Expert
e-Expert
(K0)
(eK0)

NOT : 4121
Réf. : 1685046280

FR NOTICE DE POSE A USAGE PROFESSIONNEL / LES PHOTOS ET LES DESSINS NE SONT PAS CONTRACTUELS
GB FITTING INSTRUCTIONS FOR PROFESSIONAL FITTERS / THE PHOTOGRAPHS AND THE DRAWINGS ARE NOT CONTRACTUAL
ES INSTRUCCIONES DE MONTAJE PARA USO PROFESIONAL / LAS FOTOGRAFÍAS Y LOS DIBUJOS NO SON CONTRACTUALES
P MANUAL DE MONTAGEM PARA UTILIZAÇÃO PROFISSIONAL / AS FOTOGRAFIAS E OS DESENHOS NÃO SÃO CONTRATUAIS
DE MONTAGEANLEITUNG FÜR PROFESSIONNELLEN EINSATZ / DIE FOTOS UND DIE ZEICHNUNGEN SIND NICHT VERTRAGLICH
IT ISTRUZIONI DI POSA AD USO PROFESSIONALE / LE FOTOGRAFIE ED I DISEGNI NON SONO CONTRATTUALI
NL MONTAGEHANDLEIDING VOOR PROFESSIONEEL GEBRUIK / DE FOTO'S EN DE TEKENINGEN ZIJN NIET CONTRACTUEEL
PL INSTRUKCJE INSTALACJI DO UŻYTKU PROFESJONALNEGO / OBRAZY I RYSUNKI NIE SĄ KONTRAKTU

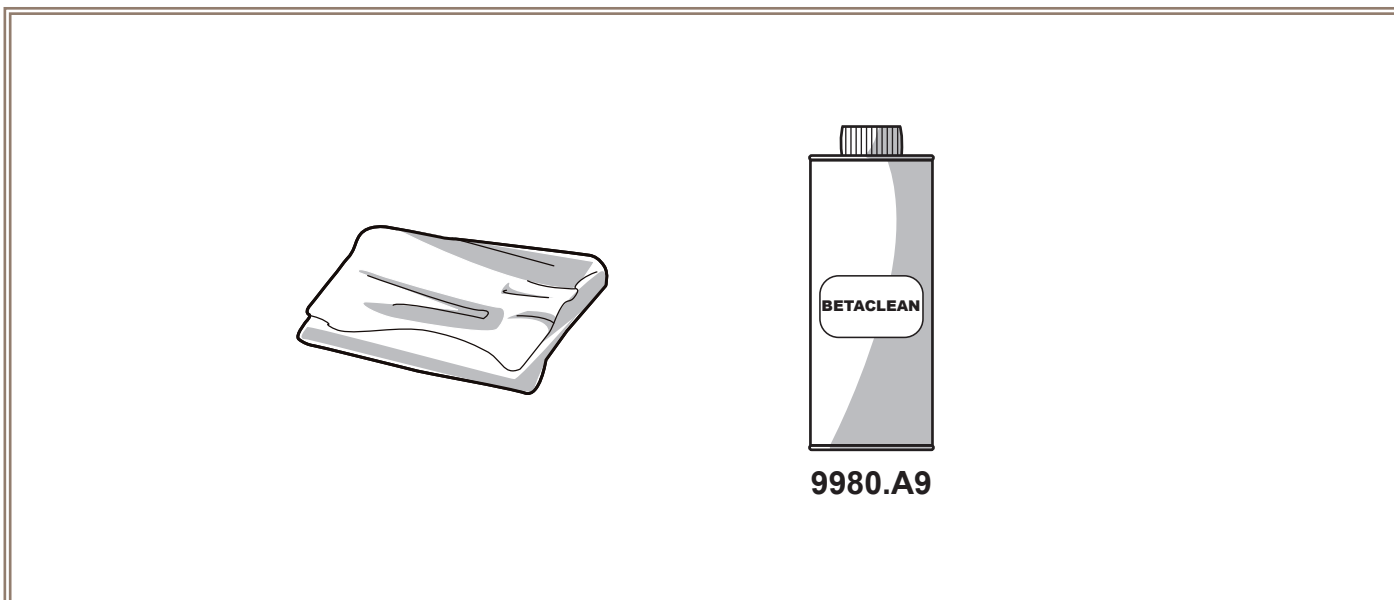

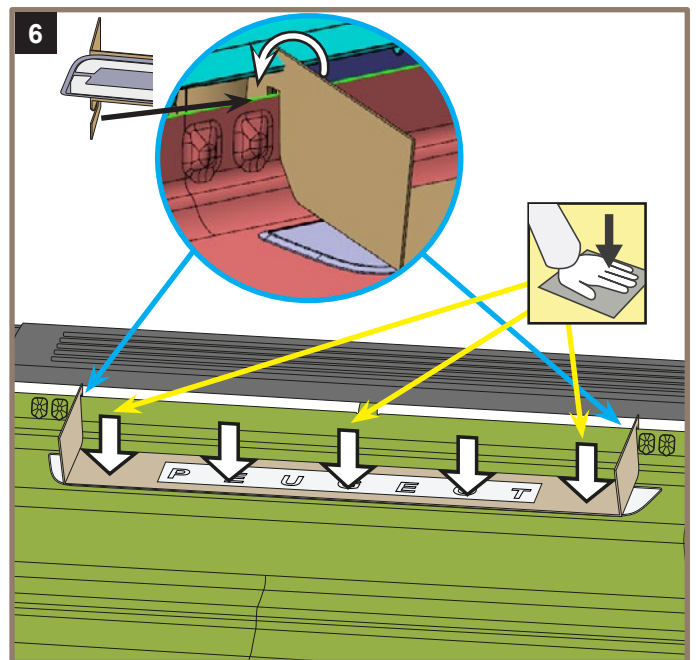
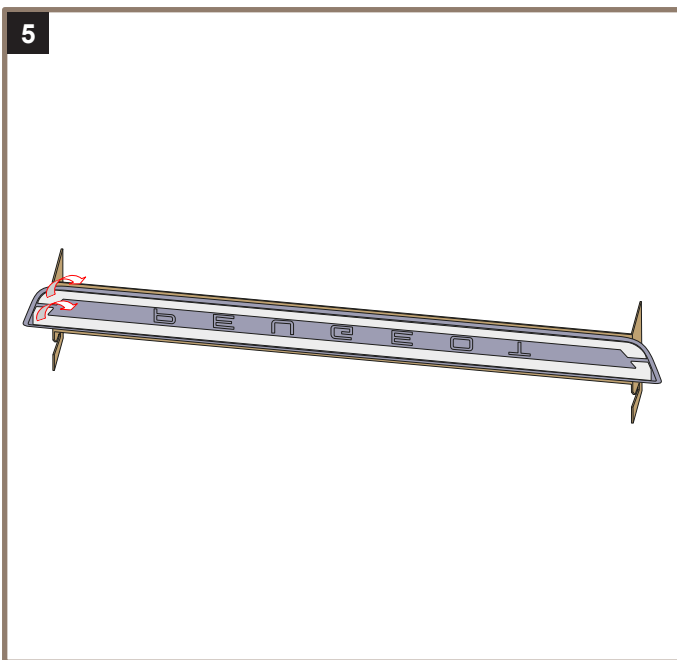
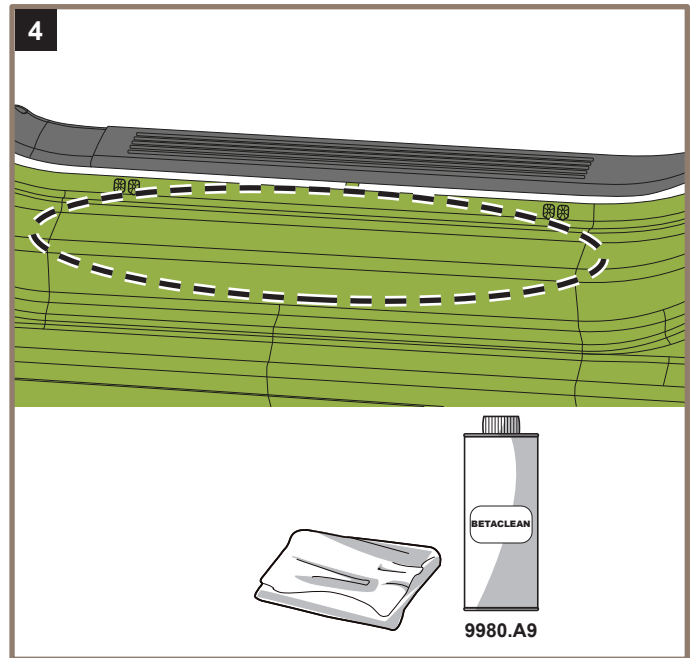
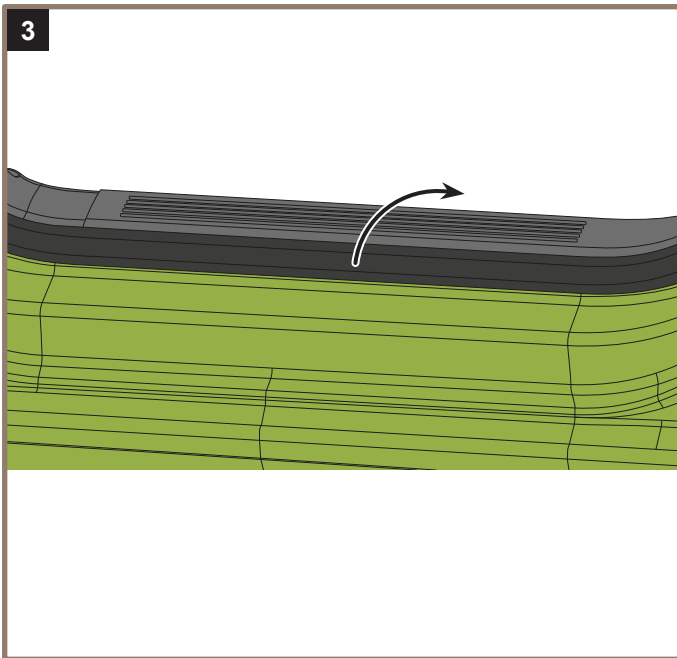
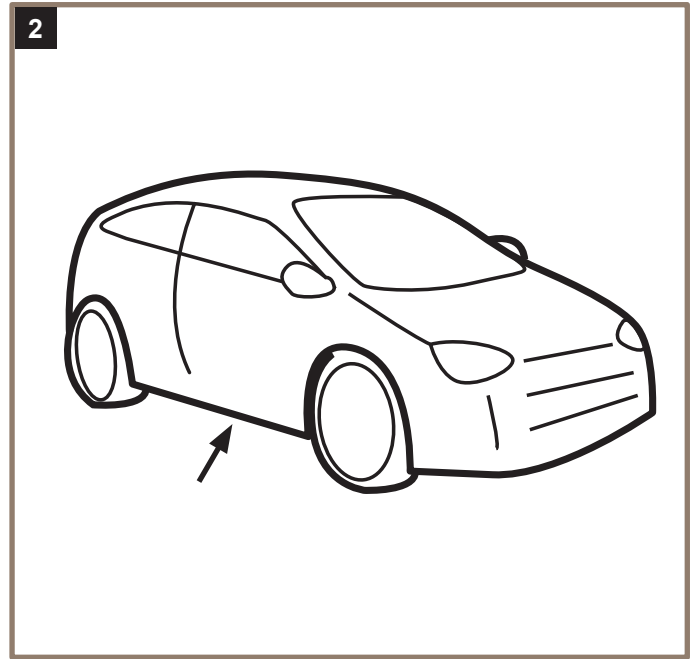
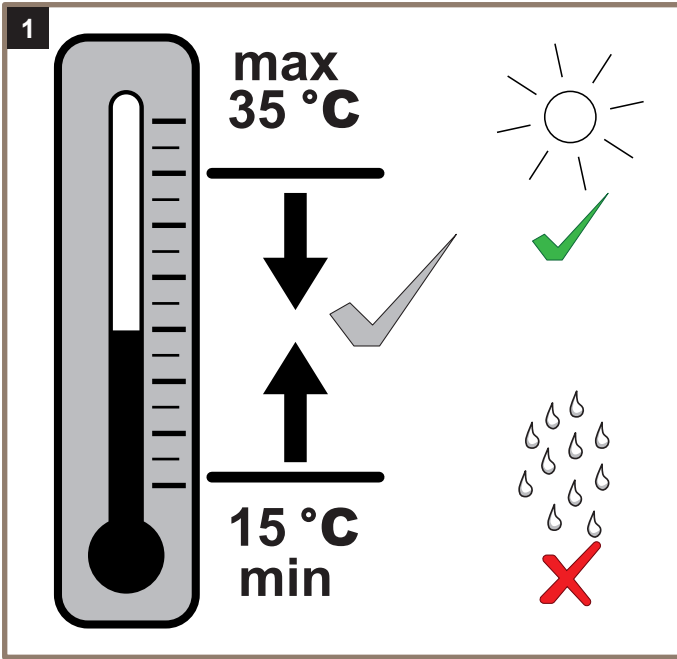

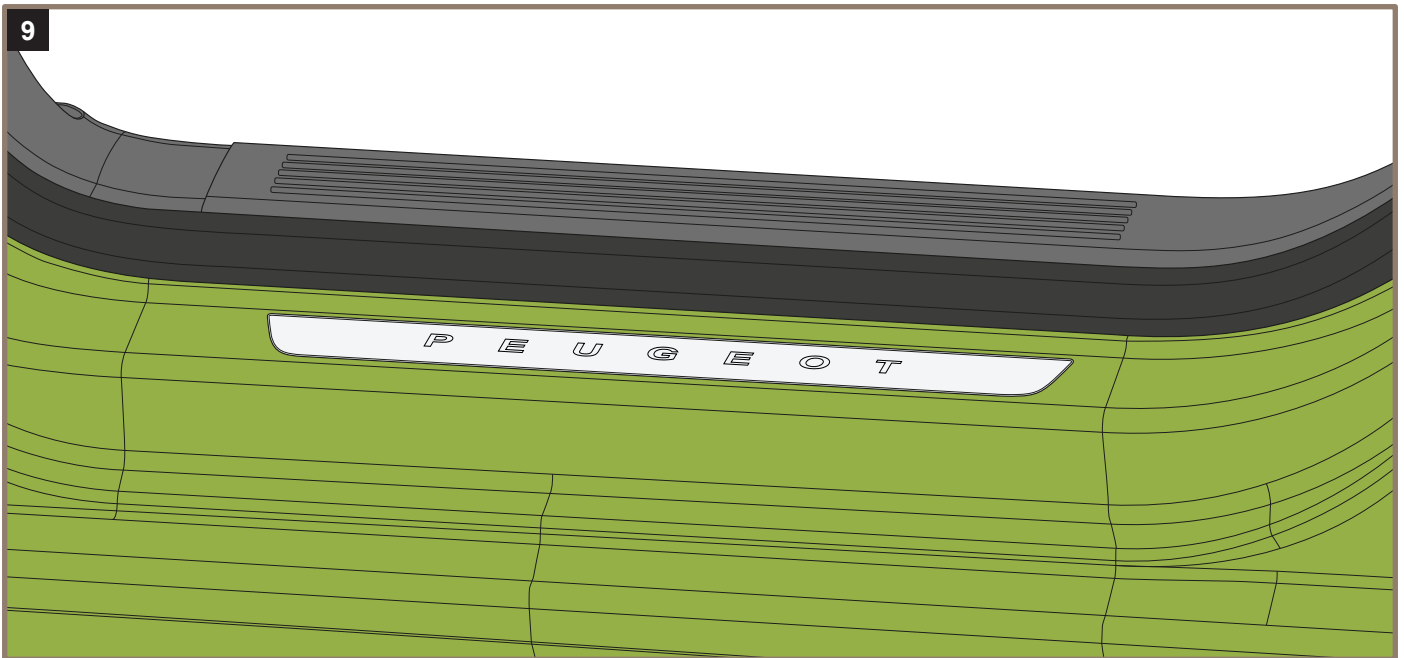
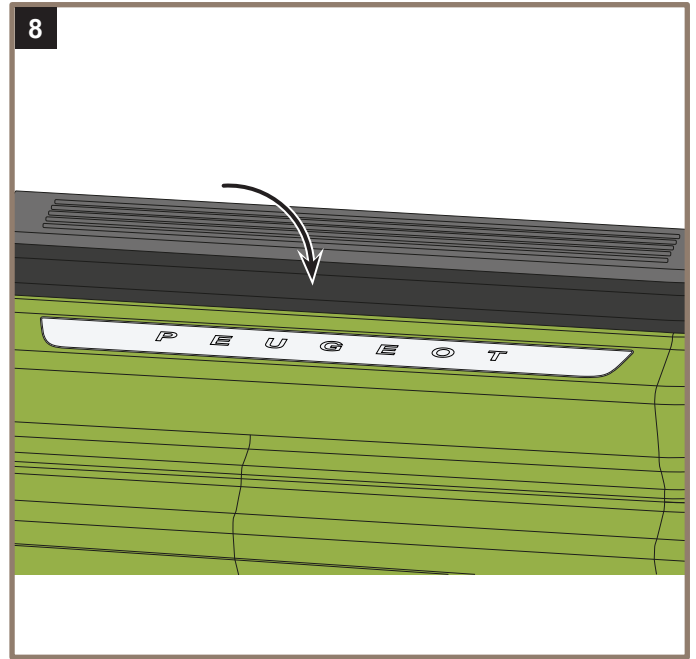
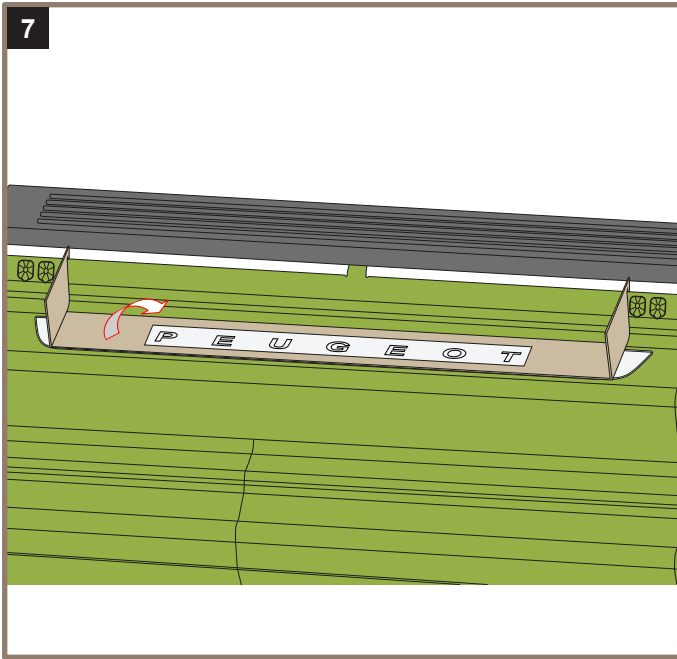

Expert (K0)

10

max
35 °C

15 °C
min

☀️ ✓

☁️ ❌

11

BETACLEAN

9980.A9

12

PEUGEOT

Expert (K0)

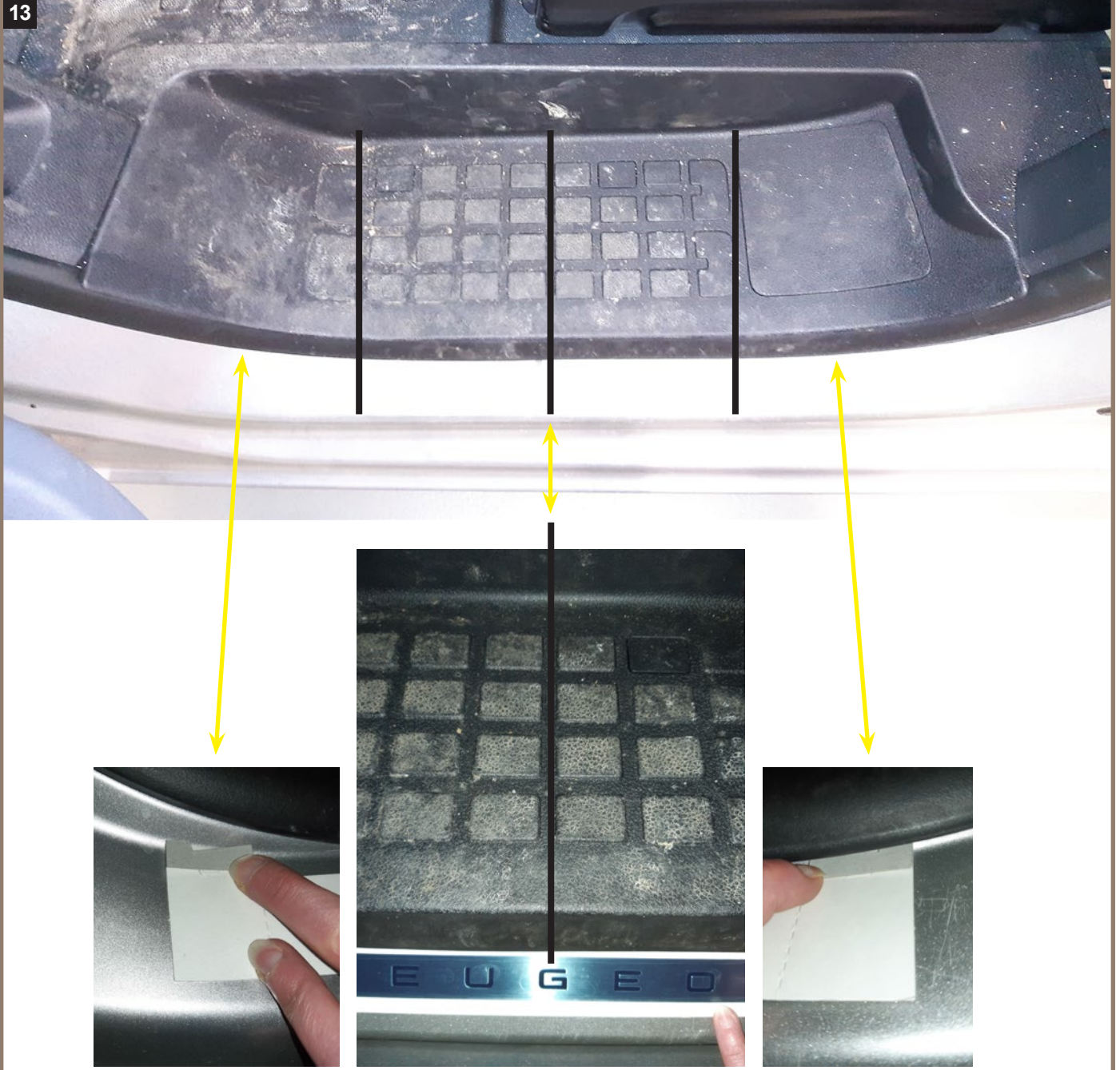

Partner (K9)

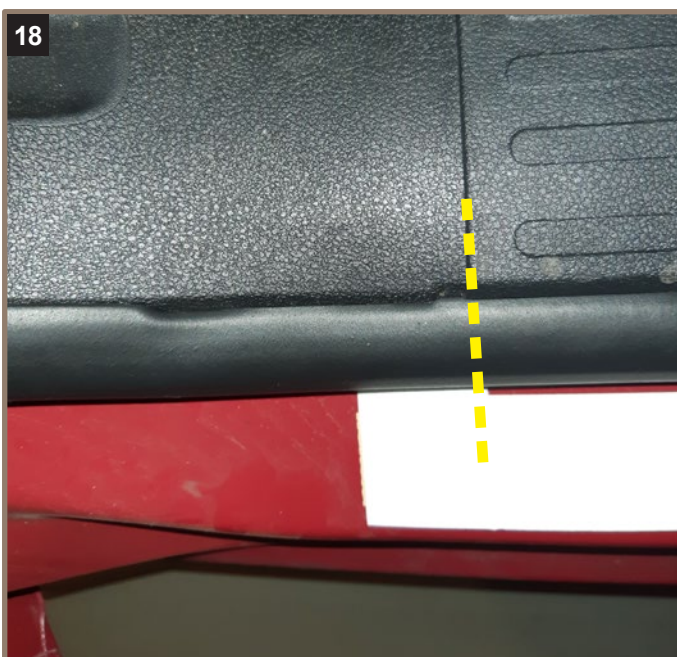
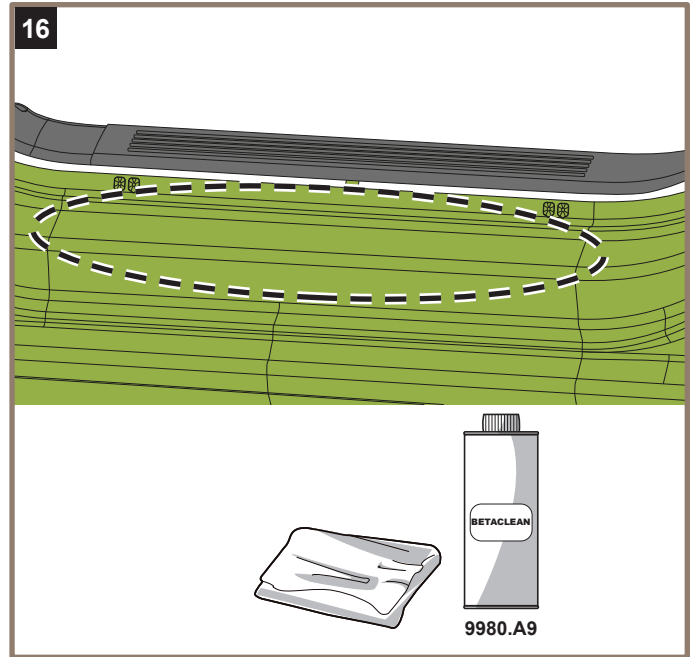
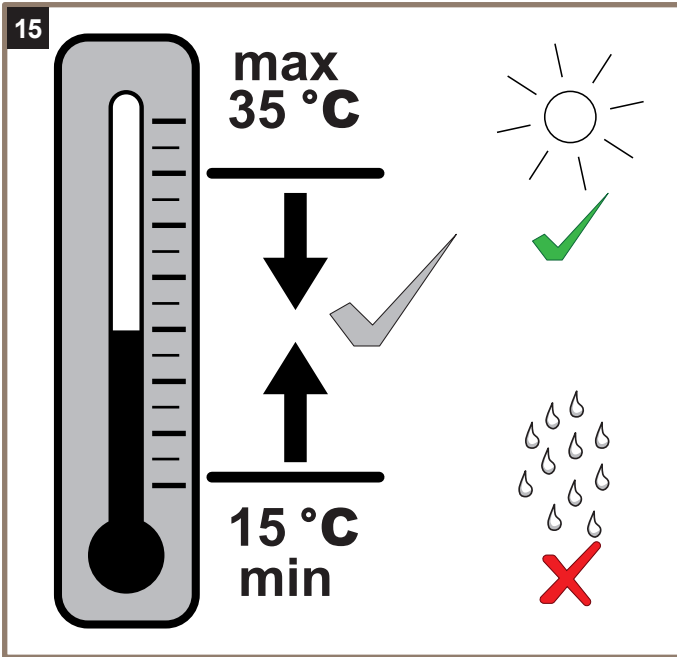

Partner (K9)



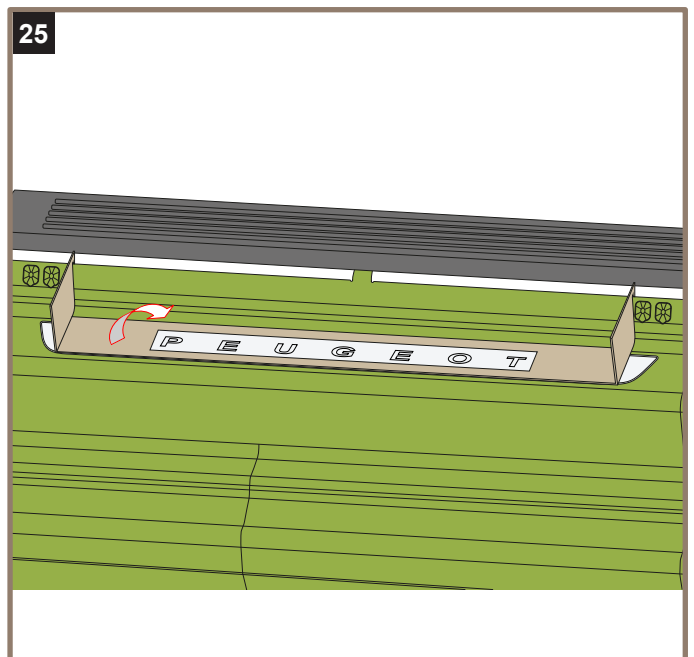
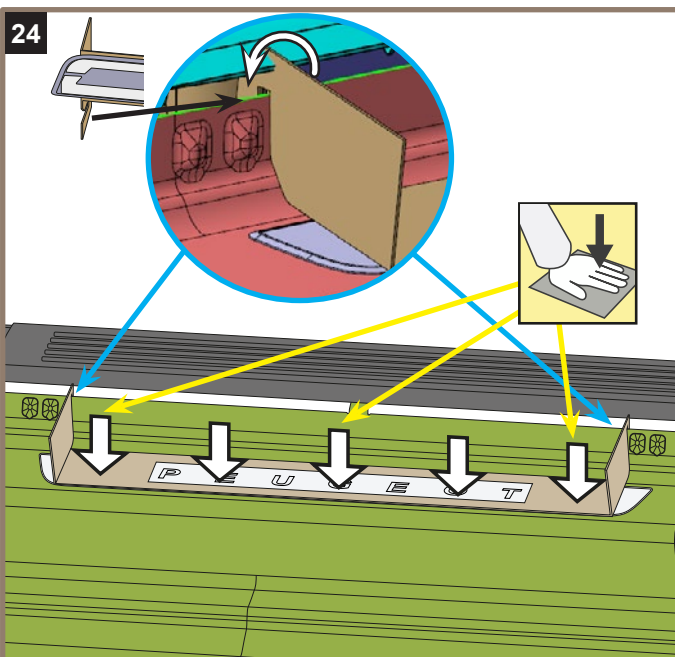
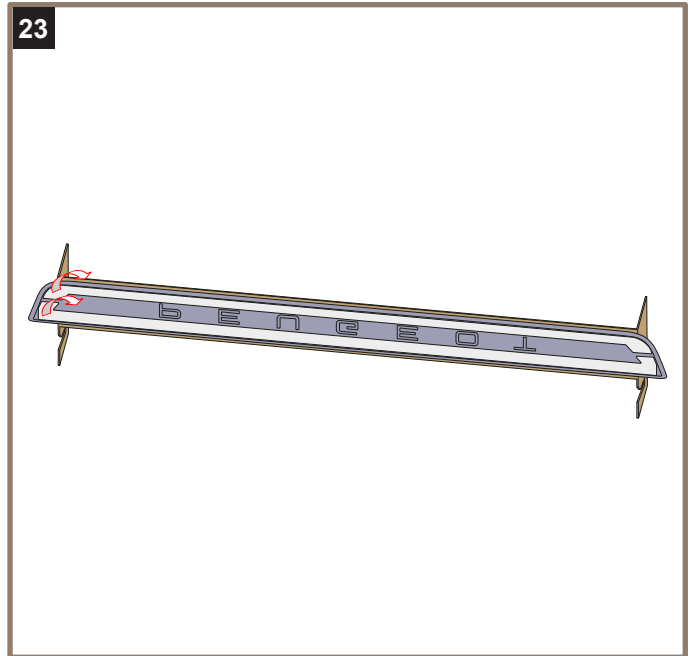
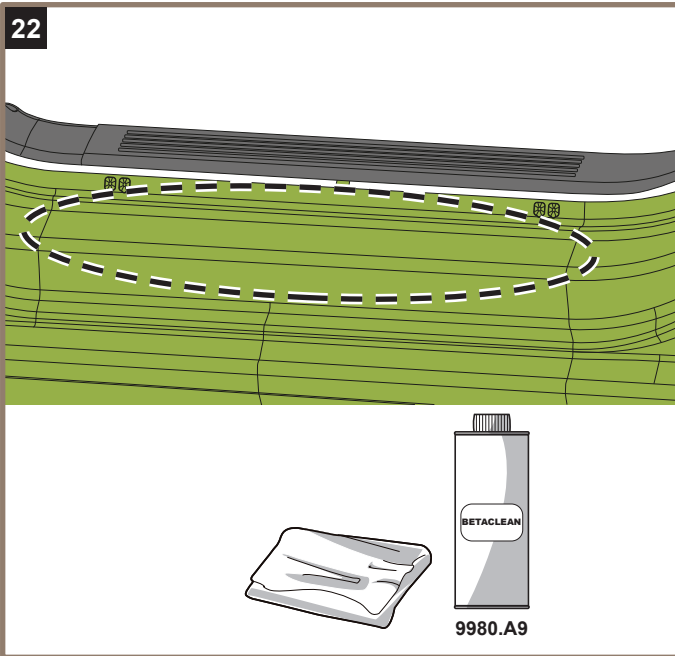
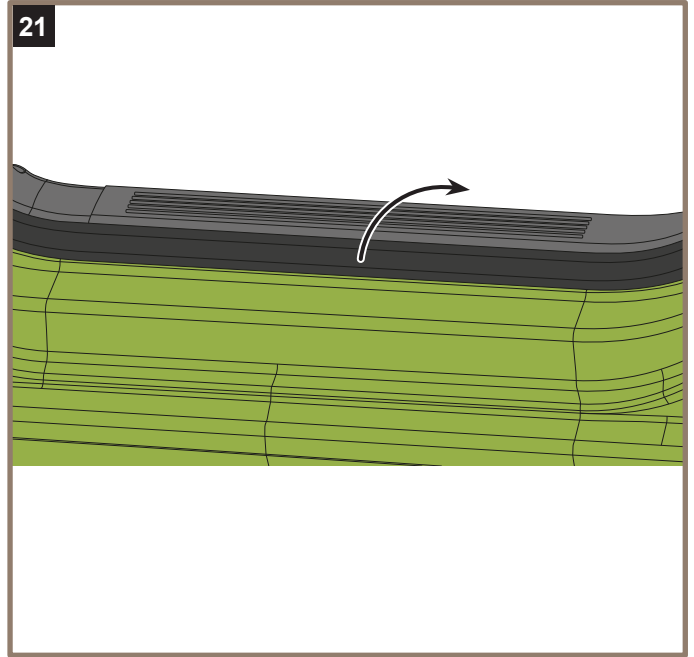
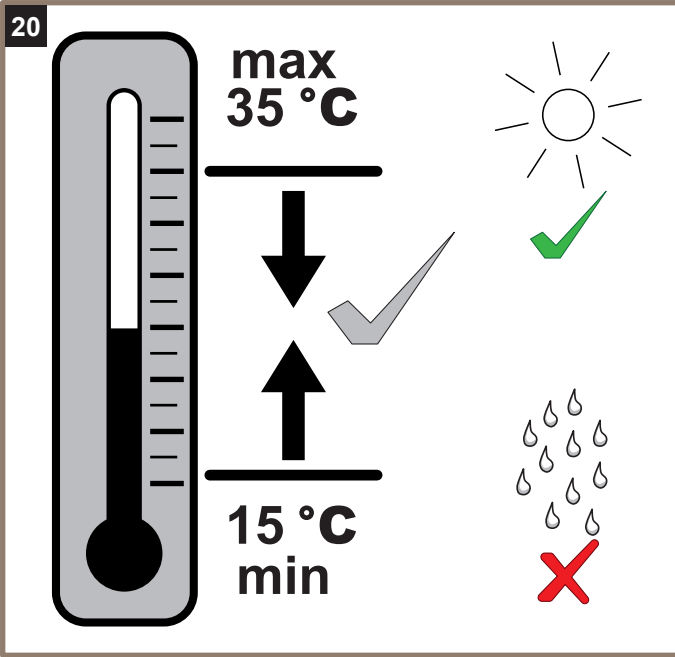

26

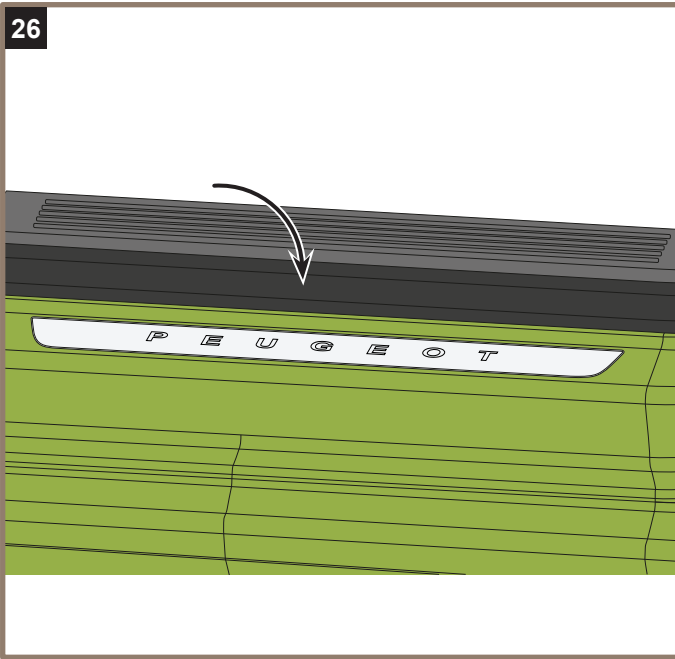

27

